

Wireless Thermal Receipt Printer

Wireless Thermal Receipt Printer User Manual

 **Warning** : Not allowed to make any change or modification to this manual without agreement. The company preserves the rights on change or modification on the technology, components, software and hardware. For further detailed information related to the products, could contact with distributor. Without any permit, any article and section of this manual is not allowed to be copied or issued in any method or any way.

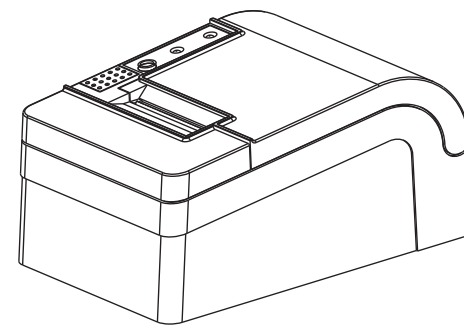

Please keep use manual for reference

Notes

- (1) Put printer on a stable place, avoid vibration and impaction.
- (2) Do not use and store the printer in the place with high temperature and humidity as well as heavy pollution.
- (3) The adapter of the printer shall be connected to a suitable grounded socket. It shall be avoided to share the same socket with large motor or other devices that may cause power fluctuation.
- (4) It shall be avoided water or conductive materials (for example metals) getting into the inside of the printer. Once happened, turn off the power immediately.
- (5) The printer shall not run the printing without paper feeding; otherwise it will damage the printing rubber roll and the thermal printing head seriously.
- (6) If the printer is not used for long time, please cut off the power of adapter.
- (7) Do not arbitrarily disassemble the printer for repair or modification.
- (8) The adapter only specially equipped with the printer.
- (9) In order to ensure the printing quality and the printer life, it is recommended to use good quality printing papers.
- (10) Please turn off the power when inserting or pulling the cables.
- (11) The plug of the adapter is the power disconnecting device. The socket connected which shall be placed nearby and easy to touch.
- (12) This product is applicable for the tropical conditions with the altitude of 5000m or below this height.

Applications

- * POS system
- * EFT POS system
- * Sports, postal service and civil aviation
- * Information and service systems
- * Information printing of the measurement instruments
- * Tax, Tab

Packing

Check the accessories:

User manual	1COPY
Printer	1SET
USB cable	1PC
Adapter (incl. power cord)	1SET
Paper roll	1ROLL
Driver (CD-ROM)	1PC
WIFI antenna	1PC (only for WIFI printer)

Main Features

- 90mm/s,120mm/s high printing speed
- Support kitchen printing and network printing;
- Support cash drawer drive;
- Small size and light with attractive shape;
- Rational structure, and convenient maintenance;
- Two kinds of interface for option: USB +Bluetooth or USB+WIFI;
- Built-in information buffer (printing information can be received while printing);
- Characters can be enlarged, over striking, and underlining. The line spacing, the left and right spacing are adjustable;
- Support the printings for bitmap with different density and downloaded graphic;
- Small power consumption and low running cost;
- Compatible with ESC/POS.
- Support network printing status motoring, multi computers connection printing and high level OPOS drive;
- Support printer authentication, computer software binding and drive high speed printing mode;
- Support multi international languages character fonts.

Technical parameters:

Printing method	Direct thermal
Printing speed	90mm/s 120mm/s
Roll paper	Size: width 57.5±0.5mm
Printing density	384dots/line
Character size	ANK character, Font A: 12 X 24 dots, Font B: 9X17 dots Simplified/ traditional Chinese: 24X24 dots
Printing command	Compatible with ESC/POS commands
Interface (optional)	USB + Bluetooth, USB+WIFI
Auto cutter	Full or Partial(optional)
Reliability	Printing head life: 50 km
Barcode	UPC-A/UPC-E/JAN13(EAN13)/JAN8(EAN8)/ CODE39/ITF/CODABAR/CODE93/CODE128
Paper thickness	0.06~0.08mm
Adaptor input voltage	AC 110V/220V, 50~60Hz
Power supply	DC 12V \approx 2.6A
Printer input voltage	DC 12V \approx 2.6A
Cash drawer control	DC 12V \approx 1A
Working environment	Temperature (0~45°C), humidity (10~80%)
Storage environment	Temperature (-10~60°C), humidity (10~90%)
Drivers	Win 9X/Win 2000/Win 2003/Win XP/Win 7/Win 8/Win 8.1/Linux/ Android/IOS

Connection

- Connect AC power cord to power, DC power cord to printer.
- Connect printer and computer/tablet.
- Connect cash drawer.

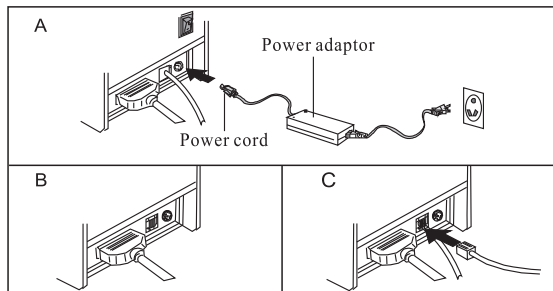

Paper roll loading

58mm thermal paper roll recommended to 58mm series.

The method of paper loading is as below:

- Open top cover.
- Drop paper roll in the hole as below.
- Pull the paper into the paper holder, then close top cover.
- Print one self-test to make sure paper correctly installed.

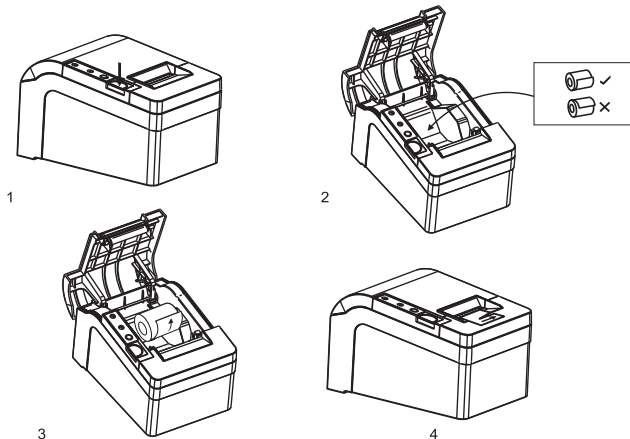

Button name, indicator LED light and function

a. FEED button

Press to FEED paper manually.

b. Status indicator

When paper roll run out, cutter error, printing head overheat, the status indicator will flickers.

c. Power indicator

Light is on means connected properly.

Selftest

Method of self-test: After the printer is connected, turn off the power, press and hold Paper feed (FEED) key and turn on the power of the printer simultaneously for about 2 seconds, then release the key, the printer will print the current state and the setting.

Method of entering hexadecimal

After the printer is connected, press and hold Paper feed (FEED) key and turn on the power of the printer for about 10s, then release the FEED key to enter the hexadecimal dump mode. The printer will print out "Hexadecimal Dump" receipt.

Printer initialization

When the printer is connected, press and hold FEED key and turn on the power of the printer simultaneously for about 20 seconds, the printer will beeper, it has been initialized to recover to factory settings.

Maintenance for cutter stuck

Method (1)

Press down the power switch key to turn off the power and then turn it on again to initialize the printer and recovery the cutter.

Method (2)

Turn the gear on the cutter of the printer to make the cutter return its initial position, then open the front cover and put the paper roll again, the printer will operate normally.

⚠ Caution: Do not pry the cover with force to avoid damaging the printing head and the auto cutter.

The driver of the printer

The wireless receipt printer provides two modes of driver, one is directly installing the driver program under WINDOWS to print, and the other is printing by commands.

(1)Directly installing the program of driver under WINDOWS

Add printer in WINDOWS, and specify the file of the driver disc to WINDOWS, it is only needed to call the driver in the program to start the printing. In this mode, it is actual that the printing is done by the printer program of WINDOWS converting the characters into graphic matrix.

Note: The driver installation method, check the driver installation icon!

(2)Direct driver by the port

In this mode, no need to install driver, it is only needed to output the characters directly to the port, and to achieve the conversion of printing by the hard character library in the printer. This mode makes the printing more convenient.

When using the mode of direct driver by the port, printing command sets shall be required to control the printing, while Model 80 Thermal Receipt Printer has been integrated ESC/POS command sets.

WIFI printer

The wireless printer is connected and the signal is transferred by radio wave. It provides advantages such as moving freely, unrestricted by line, quickly and easily installing as well as easy expansion and so on.

WIFI printer has an transmission distance of 50m-100m.

Wireless infrastructure mode: All data transmission and network flow are processed by way of wireless router (Wifi 802, 11b/g/n Protocol) or the access point. The mode provides the advantages as follows:

The signal is stable, safe and can be expanded flexibly.

The Wifi module used in the printer is low power consumption embedded Wifi module, it adopts static IP (IP shall not have any conflict with other devices that are connected with the router). Turn on printer, users could set up Wifi module by tools, in the option of network setting.

The working mode of Wifi module is to use: STA+Server (TCP Protocol), e.g. the server mode. The server mode supports text printing and driver printing. Once the setting is made, the printer will connect with server automatically.

Wifi printer setting

It is to achieve the Wifi working parameters setting, the connection between printer with the wireless router.



1. Please make sure the computer is connected with the wireless router. Connect the printer with USB line, turn on the printer. In CD, open the “tools” for printer, find the printer setting, choose the right usb port, print a test page, if print successfully, turn to “Advance” setting, see the picture as below:

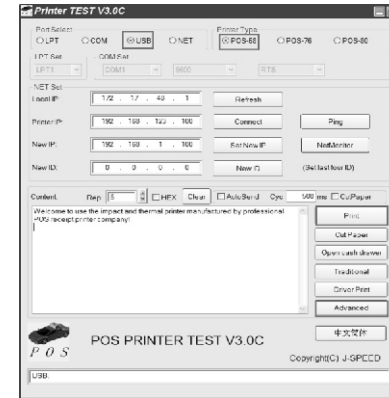

2. Click “network setting”, set up the printer IP address, subnet mask, gateway address as well as the related information to wireless router, click “set up above contents”. the printer will beep a sound. then restart the printer, wait around 30 seconds, the printer will print a receipt automatically, it means the wifi setting successfully.

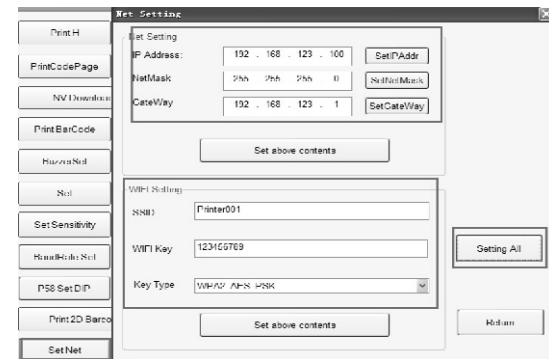

3. Set up driver port for wifi printer. Click “Start” once, open “Control panel”, double click “Printer and Fax”, find the installed printer driver, see the picture as below:



4. Click right key “Properties” of the driver “Port”, choose “IP Port” option, choose the IP port, then click “Application”, see the picture as below:

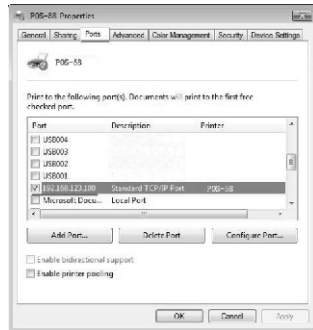

5. Printing test

Click “Test printing” in “Normal” option, if the page is printed out, it means that the port configuration is correct.

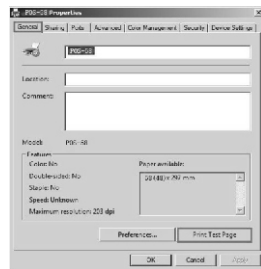

After completing the above mentioned procedures, the printer setting has been finished, it can be used for printing.

Bluetooth printer

Bluetooth: It is a kind of technology with short distance wireless connection which globally used, using the same 2.4GHz nearby free charge and free application for frequency radio range with microwave. It can transfer data without alignment, with an effective transmission range of 10m. The Bluetooth printer carries out data transmission by matching with the Bluetooth device, the receiving master transfers the data to the printer and print it out. Hand-held terminal with Bluetooth interface, laptop and other information terminals could print via Bluetooth interface.

Mini receipt printer compatible with Bluetooth 2.1/4.0 standard, with the power level of CLASS 2, and effective transmission distance is 10M. The name of the device is Printer 001, the initial password is “0000”. Users may change the name of the device and the password if necessary.

The Bluetooth printer need to be paired with the main device of Bluetooth before working, the process of pairing will be started by the main device.

For detail pairing method, please refer to the function instructions for main device of Bluetooth.

When pairing, the Bluetooth printer should power on.

Note: If the name of the printer is not changed, please do not power on other printers at the same time when pairing, otherwise it cannot identify which printer is paired successfully.

Bluetooth printer setting

1. Connect the printer with computer, turn on the printer. Open the “tools” folder in printer CD, find the printer setting tools, choose the port and print a test page, if works, then enter into “Advanced” option, see the picture as below:

Note: Bluetooth printer and the port setting procedures: firstly connect the power and turn on the Bluetooth printer, connect the Bluetooth device to USB interface of the computer (master), a Bluetooth icon at the lower right corner on the desktop will appear.

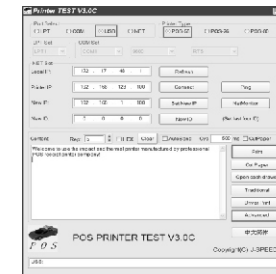

2. Click “Bluetooth setting”, set the related information such as the name of the Bluetooth device and the password, then click “Setting”. The printer will “beep” a sound. Then restart the computer and check if the information of the self-test page printed matches with the settings.

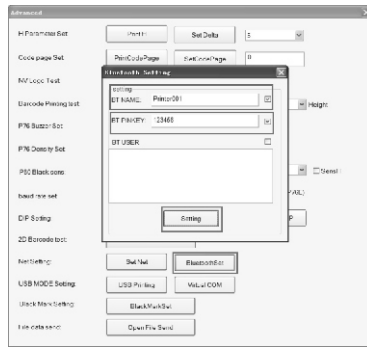

- 3、 Enter“Control Panel”--“Hardware and Sound”--“Add a Blue tooth device”。 (Computer should support Bluetooth function) 。 See picture as below :

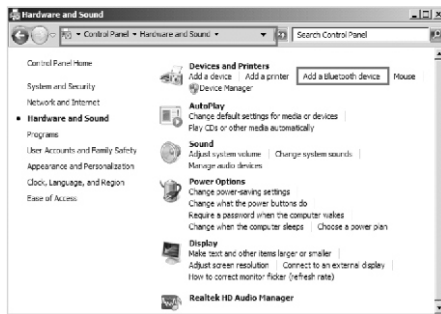

- 4、 Default name of Bluetooth setting.Choose“Printer001”,click “Next”.

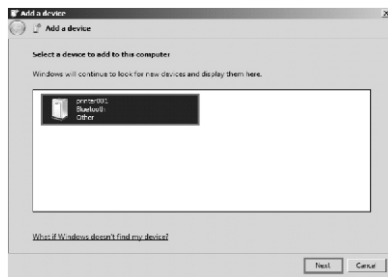

- 5、 Choose“Enter the device's pairing code” , enter the pass word“123456” , add the device, see pictures as below :

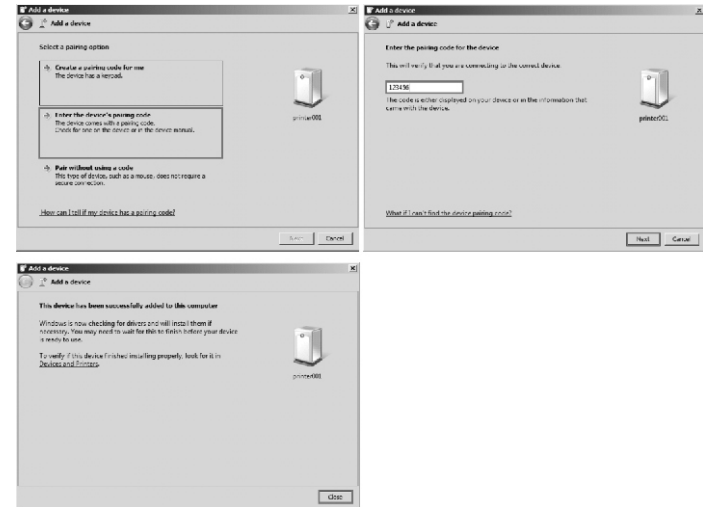

- 6、 After adding the device, choose “Equipment and printer”, find the added Bluetooth device Printer001, click the properties of hardware, check the port information of the device. See picture as below

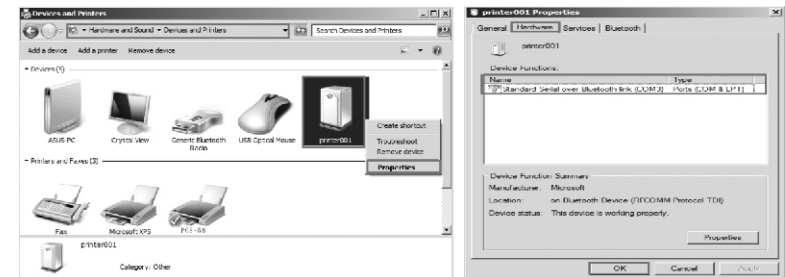

- 7、 After installing the printer driver, find the icon of driver, check the properties of it, choose the right port and print a test page via driver. See the pictures as below:

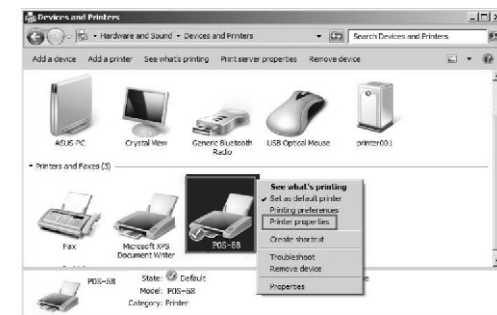

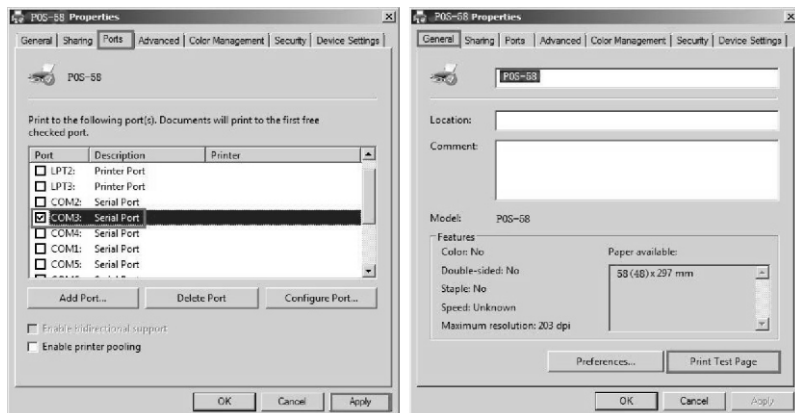

Printer cleaning

When any of the followings occurs, the printing head shall be cleaned:

- (1) Printing is not clear
- (2) Certain column on the printed page is not clear
- (3) Paper feeding makes louder noise

Printing head cleaning procedures:

- (1) Turn off the power of the printer, open the upper cover, remove the paper if any;
- (2) If just printing, wait till the printing head becomes cool completely;
- (3) Take the absolute ethyl alcohol with cotton cloth(shall wring up) to erase the dust and dirt on the surface of the printing head ;
- (4) When the absolute ethyl alcohol is evaporated completely, close the upper cover, and print the test page again.

Notice:

- (1)It shall make sure the power is off for daily maintenance.
- (2)Do not touch the surface of the printing head with hands or metal parts; and do not use tools like tweezers to scratch the printing head, printing rubber roll and the surface of the sensor.
- (3)Do not use the organic solutions such as gasoline and acetone and so on.
- (4)Printing can be continued only after the absolute ethyl alcohol evaporates completely.