

1. Control Command List

Num	Control Code	Function
01	HT	Horizontal tab
02	LF	Print and line feed
03	CR	Print and carriage return
04	DLE EOT n	Real-time status transmission
05	DLE ENQ n	Real-time response to computer
06	ESC SP n	Set right-side character spacing
07	ESC ! n	Select print modes
08	ESC % n	Select/Cancel user-defined character set
09	ESC &	Define user-defined characters
10	ESC *	Select bit-image mode
11	ESC - n	Turn underline mode on/off
12	ESC 2	Select default line spacing
13	ESC 3 n	Set line spacing
14	ESC <	Return home
15	ESC ? n	Cancel user-defined characters
16	ESC @	Initialize printer
17	ESC D [n]k NUL	Set horizontal tab position
18	ESC E n	Turn emphasized mode on/off
19	ESC G n	Turn double-strike mode on/off
20	ESC J n	Print and feed paper
21	ESC K n	Print and reverse feed paper
22	ESC M n	Select an character font
23	ESC R n	Select an international character set
24	ESC U n	Turn unidirectional print mode on/off
25	ESC a n	Select justification mode
26	ESC c 5 n	Enable/Disable panel button
27	ESC d n	Print and feed n lines
28	ESC e n	Print and reverse feed n lines
29	ESC p m t1 t2	Generate pulse for drawer
30	ESC r n	Select print color (#)
31	ESC t n	Select character code table
32	ESC { n	Turn upside-down printing mode on/off
33	GS (A pL pH n m	Hexadecimal Dumping mode
34	①GS V m ②GS V m n	Select cut mode and cut paper
35	GS a n	Enable/Disable Automatic status back
36	GS r n	Transmit status
37	GS z 0 t1 t2	Set on-line recovery wait time
38	FS ! n	Set Kanji character font mode
39	FS &	Select Kanji character mode
40	FS - n	Select/Cancel Kanji character underline mode

41	FS .	Cancel Kanji characters mode
42	FS 2 c1 c2 d1...dk	Define user-defined Kanji characters
43	FS ? c1 c2	Cancel user-defined Kanji characters
44	FS S n1 n2	Set Kanji characters spacing
45	FS W n	Select/Cancel Kanji character double and quadruple-size print
46	GS (F pL pH a m nL nH	Set the offset of black mark position
47	GS FF	Feed paper to the black mark position
48	ESC ^ n	Set reverse feed length (*)
49	ESC ~ nL nH	Set length of the receipt (*)
50	ESC DEL	Feed paper to the end of receipt (*)
51	GS <	Reset print head and feed black-mark paper to the start position
52	ESC 0E9H	Print start code (*)
53	ESC }	Print end code (*)

- # Available in POS76series printer only

2. COMMANDS

2.1 Command Notation

X X X X

[Name]	The name of the command.
[Format]	The code sequence.
[Range]	Gives the allowable ranges for the arguments.
[Description]	Describes the command's function.
[Notes]	Provides important information on setting and using the printer command, if necessary.
[Details]	Describes the usage of the command in detail.
[Default]	Gives the default values, if any, for the command parameters.
[Reference]	Lists related commands.
[Example]	Gives examples of how to use the command.

ASCII indicates the American Standard Code for Information Interchange

Hex indicates the hexadecimal equivalents.

Decimal indicates the decimal equivalents.

[]*k* indicates the contents of the bracket [] should be repeated *k* times.

2.2 Explanation of Terms

(1) Receive buffer

The receive buffer is a buffer that stores, as is, the data received from the host (the reception data). The reception data is stored in the receive buffer temporarily, and is then processed sequentially.

(2) Print buffer

The print buffer is a buffer that stores the image data to be printed.

(3) Print buffer full

This is the state where the print buffer is full. If new print data is input while the print buffer is full, the data in the print buffer is printed out and a line feed is executed. This is the same operation as the LF command operation.

(4) Start of line

The start of line state satisfies the following condition:

- There is no print data (including spaces and portions of data skipped due to bit image data) currently in the print buffer.

(5) Printable area

The maximum range of print area under the printer's specifications. The max print area of the printer is 400/160 inch.

(6) Ignore

The state in which all codes, including parameters, are read in and discarded, and nothing happens.

(7) Invalidation

The state in which command codes are read in and discarded, and parameters are processed as normal data.

(8) Inch

A unit of length. One inch is 25.4 mm.

(9) MSB

Most Significant Bit

(10) LSB

Least Significant Bit

2. 3 Control Commands

1. HT

[Name]	Horizontal Tab	
[Format]	ASCII	HT
	Hex	09
	Decimal	10

[Description] Moves the print position to the next horizontal tab position.

- [Details]
- This command is ignored unless the next horizontal tab position has been set.
 - If the next horizontal tab position exceeds the printing area, the printer sets the printing position to [Printing area width + 1].

- Horizontal tab positions are set with **ESC D**.
- The default setting of the horizontal tab position for the paper roll is font B (9 X 9) every 8 characters (9th, 17th, 25th, ... column).

[Reference] **ESC D**

2. LF

[Name] Print and line feed

[Format] ASCII LF
 Hex 0A
 Decimal 10

[Description] Prints the data in the print buffer and feeds one line based on the current line

[Detail] This command sets the print position to the beginning of the line.

[Reference] **ESC 2, ESC 3**

3. CR

[Name] Print and carriage return

[Format] ASCII CR
 Hex 0D
 Decimal 13

[Description] Print out the data in the print buffer but do not feed paper.

[Detail] Sets the print starting position to the beginning of the line.

[Reference] **LF**

4. DLE EOT n

[Name] Real-time status transmission

[Format] ASCII DLE EOT n
 Hex 10 04 n
 Decimal 16 4 n

[Range] $1 \leq n \leq 4$

[Description] Transmits the selected printer status specified by n in real-time, according to the following parameters:

- n = 1: Transmit printer status
- n = 2: Transmit off-line status
- n = 3: Transmit error status
- n = 4: Transmit paper roll sensor status

[Details] • In sending status, printer sends a byte without validation of DSR signal.

- This command is executed even when the printer is off-line, the receive buffer is full, or there is an error status with a serial interface model.
- With a parallel interface model, this command can not be executed when the printer is busy.
- When use **GS a** to enable Automatic Status Back (ASB), the status transmitted by **DLE EOT** and the ASB status must be differentiated by using the table in Appendix D.
- This command is valid even when the printer is disabled with **ESC =** (Select peripheral device).

- This command is being processed as soon as received by the printer.

[Note] • The status is transmitted whenever the data sequence of <10>H<04>H<n>(1 . n . 4) is received.

Example:

In **ESC m nL nH d1...dk**, d1=<10>H, d2=<04>H, d3=<01>H

- This command should not be used within the data sequence of another command that consists of 2 or more bytes.

Example:

If you attempt to transmit **ESC 3 n** to the printer, but DTR (DSR for the host computer) goes to MARK before n is transmitted and then **DLE EOT 3** interrupts before n is received, the code <10>H for **DLE EOT 3** is processed as the code for **ESC 3 <10>H**.

n = 1: Printer Status

Bit	0/1	Hex	Decimal	Function
0	0	00	0	Fixed to Off.
1	1	02	2	Fixed to On.
2	0	00	0	Drawer open
	1	04	4	Drawer close
3	0	00	0	On-line
	1	08	8	Off-line
4	1	10	16	Fixed to On.
5	0	00	00	Recover until on-line
	1	20	32	Wait for on-line recover
6	--	--	--	Undefined.
7	0	00	00	Fixed to Off.

n = 2: Off-line Status

Bit	0/1	Hex	Decimal	Function
0	0	00	0	Fixed to Off.
1	1	02	2	Fixed to On.
2	0	00	0	Top cover close
	1	04	4	Top cover open
3	0	00	0	Paper is not being fed by using the FEED button.
	1	08	8	Paper is being fed by the FEED button.
4	1	10	16	Fixed to On.
5	0	00	0	No shortage of paper
	1	20	32	Shortage of paper
6	0	00	0	No error
	1	40	64	Error occurs

7	0	00	0	Fixed to Off.
---	---	----	---	---------------

n = 3: Error Status

Bit	0/1	Hex	Decimal	Function
0	0	00	0	Fixed to Off.
1	1	02	2	Fixed to On.
2		---	---	Undefined.
3	0	00	0	No auto-cutter error.
	1	08	8	Auto-cutter error occurs.
4	1	10	16	Fixed to On.
5	0	00	0	No unrecoverable error.
	1	20	32	Unrecoverable error occurs.
6	0	00	0	Temperature and voltage of print head is normal
	1	40	64	Temperature and voltage of print head is over range
7	0	00	0	Fixed to Off.

n = 4: Feed Status

Bit	1/0	Hex	Decimal	Function
0	0	00	0	Fixed to Off.
1	1	02	2	Fixed to On.
2,3	0	00	0	Roll paper near-end sensor: paper adequate.
	1	0C	12	Roll paper near-end sensor: paper near end.
4	1	10	16	Fixed to On.
5,6	0	00	0	Paper present.
	1	60	96	Paper not present.
7	0	00	0	Fixed to Off.

5. DLE ENQ n

[Name] Send real-time request to printer

[Format] ASCII DLE ENQ n
Hex 10 05 n
Decimal 16 5 n

[Range] n = 0, n = 2

[Description] Responds to a request from the host computer.

n = 0: Recover from an error;

n = 2: Recover from an error after clearing the receive and print buffers;

[Details]

- The command n=0 is ignored unless the error caused by paper shortage has occurred.
- The command n=2 is effective only when a mechanical error or an auto-cutter error occurs.

- The printer starts processing data upon receiving this command.
- This command is executed even when the printer is off-line, the receive buffer is full, or there is an error status with a serial interface model. With a parallel interface model, this command can not be executed when the printer is busy.
- **DLE ENQ 2** enables the printer to recover from an error after clearing the data in the receive buffer and the print buffer. The printer retains the settings (by **ESC !**, **ESC 3**, etc.) that were in effect when the error occurred. The printer can be initialized completely by using this command and **ESC @**. This command is enabled only for errors that have the possibility of recovery, except for print head temperature error.
- When the printer is disabled with **ESC =** (Select peripheral device), the error recovery functions (**DLE ENQ 1** and **DLE ENQ 2**) are enabled, and the other functions are disabled.

[Note]

- ESC * m nL nH [d] nL + 2 5 6 nH d1=<10>H d2=<05>H d3=<1>H The status is also transmitted whenever the data sequence of <10>H<05>H< n>(1 . n . 2) is received.

Example:

In **ESC m nL nH dk**, d1 = <10>H, d2 = <05>H, d3 = <01>H

- This command should not be contained within another command that consists of two or more bytes.

Example:

If you attempt to transmit **ESC 3 n** to the printer, but DTR (DSR for the host computer) goes to MARK before n is transmitted, and **DLE ENQ 2** interrupts before n is received, the code <10>H for **DLE ENQ 2** is processed as the code for **ESC 3 <10>H**.

[Reference] DLE EOT, GS z 0

6. ESC SP n

[Name]	Set right-side character spacing			
[Format]	ASCII	ESC	SP	n
	Hex	1B	20	n
	Decimal	27	32	n
[Range]	0 ≤ n ≤ 255			
[Description]	Sets the character spacing for the right side of the character to [n × 0.159mm {1/160inch}]			
[Details]	• The right-side character spacing for double-width mode is twice the normal value. When characters are enlarged, the right-side character spacing is n times normal value.			
[Default]	n = 0			

7. ESC ! n

[Name]	Select print mode(s)			
[Format]	ASCII	ESC	!	n
	Hex	1B	21	n
	Decimal	27	33	n
[Range]	0 ≤ n ≤ 255			

[Description] Selects print mode(s) using n as follows:

Bit	1/0	Hex	Decimal	Function
0	0	00	0	Character font A (9 x 9)
	1	01	1	Character font B (7 x 9)
1,2		---	---	Undefined.
3	0	00	0	Emphasized mode not selected.
	1	08	8	Emphasized mode selected.
4	0	00	0	Double-height mode not selected.
	1	10	16	Double-height mode selected.
5	0	00	0	Double-width mode not selected.
	1	20	32	Double-width mode selected.
6		---	---	Undefined.
7	0	00	0	Underline mode not selected.
	1	80	128	Underline mode selected.

[Details]

- When both double-height and double-width modes are selected, quadruple size characters are printed.
- The printer can underline all characters, but can not underline the space set by **HT** or 90° clockwise rotated characters.
- The underline mode set by this command do not affect the Kanji character print mode, which is set by **HT** command.

[Default] n = 1

[Reference] **ESC** -, **ESC** E

8. **ESC** % n

[Name] **Select/cancel user-defined character set**

[Format]

ASCII	ESC	%	n
Hex	1B	25	n
Decimal	27	37	n

[Range] $0 \leq n \leq 255$

[Description] Selects or cancels the user-defined character set.

- When the LSB of n is 0, the user-defined character set is canceled, and the built-in character set is automatically selected.
- When the LSB of n is 1, the user-defined character set is selected.

[Details]

- n is available only for the least significant bit.
- When the user-defined character set is canceled, the internal character set is automatically selected.

[Default] n = 0

[Reference] **ESC** &, **ESC** ?

9. **ESC** & y c1 c2 [x1 d1 ... d(y×x1)] ... [xk d1 ... d(y×xk)]

[Name] **Define user-defined characters**

[Format]

ASCII	ESC	&	y	c1	c2	[x1 d1...d(y×x1)]...[xk d1... d(y×xk)]
Hex	1B	26	y	c1	c2	[x1 d1...d(y×x1)]...[xk d1... d(y×xk)]

	Decimal 27 38 y c1 c2 [x1 d1...d(y×x1)]...[xk d1... d(y×xk)]
[Range]	<p>y = 2</p> <p>32 ≤ c1 ≤ c2 ≤ 126</p> <p>0 ≤ x ≤ 12 Font A (9 × 9)</p> <p>0 ≤ x ≤ 9 Font B (7 × 9)</p> <p>0 ≤ d1 ... d(y × x) ≤ 255</p>
[Description]	<p>Defines user-defined characters.</p> <ul style="list-style-type: none"> • y specifies the number of bytes in the vertical direction. • c1 specifies the beginning character code for the definition, and c2 specifies the final code. • x specifies the number of dots in the horizontal direction.
[Details]	<ul style="list-style-type: none"> • The allowable character code range is from ASCII code <20>H to <7E>H (95 characters). • It is possible to define multiple characters for consecutive character codes. If only one character is desired, use c1 = c2. • d is the dot data for the characters. The dot pattern is in the horizontal direction from the left side. Any remaining dots on the right side are blank. • The data to define a user-defined character is (y × x) bytes. • Set a corresponding bit to 1 to print a dot or 0 to not print a dot. • This command can define different user-defined character patterns by each fonts. To select a font, use ESC ! • The user-defined character definition is cleared when: <ul style="list-style-type: none"> 1) ESC @ is executed. 2) ESC ? is executed. 3) The printer is reset or the power is turned off. • The max number of characters is 8. • When the maximum number of user-defined characters is defined, it is possible to redefine user-defined characters for the defined ASCII code, but not for the new ASCII code.
[Default]	The internal character set
[Reference]	ESC % , ESC ?

10. ESC * m nL nH d1...dk

[Name]	Select bit-image mode																					
[Format]	<table border="0"> <tr> <td>ASCII</td> <td>ESC</td> <td>*</td> <td>m</td> <td>nL</td> <td>nH</td> <td>d1...dk</td> </tr> <tr> <td>Hex</td> <td>1B</td> <td>2A</td> <td>m</td> <td>nL</td> <td>nH</td> <td>d1...dk</td> </tr> <tr> <td>Decimal</td> <td>27</td> <td>42</td> <td>m</td> <td>nL</td> <td>nH</td> <td>d1...dk</td> </tr> </table>	ASCII	ESC	*	m	nL	nH	d1...dk	Hex	1B	2A	m	nL	nH	d1...dk	Decimal	27	42	m	nL	nH	d1...dk
ASCII	ESC	*	m	nL	nH	d1...dk																
Hex	1B	2A	m	nL	nH	d1...dk																
Decimal	27	42	m	nL	nH	d1...dk																
[Range]	<p>m = 0, 1</p> <p>1 ≤ (nL+nH × 256) ≤ 1023</p> <p>0 ≤ nL ≤ 255</p> <p>0 ≤ nH ≤ 3</p> <p>0 ≤ d ≤ 255</p> <p>k = nL+nH × 256</p>																					
[Description]	<p>Selects a bit-image mode using m for the number of dots specified by nL and nH, as follows:</p> <ul style="list-style-type: none"> • The nL and nH indicate the number of dots of the bit image in the horizontal 																					

direction. The number of dots is calculated by $nL + nH \times 256$.

- If the bit-image data input exceeds the number of dots to be printed on a line, the excess data is ignored.
- d indicates the bit-image data. Set a corresponding bit to 1 to print a dot or to 0 to not print a dot.
- Selects a bit-image mode using m for the number of dots specified by nL and nH , as follows:

m	Mode	Vertical Direction Dot Density	Horizontal Direction Dot Density
0	8-dot single-density	60dpi	90
1	8-dot double-density	60	180

- [Details]
- If the value of m is out of the specified range, nL and data following are processed as normal data.
 - After printing a bit image, the printer returns to normal data processing mode.
 - The relationship between the image data and the dots to be printed is as follows:

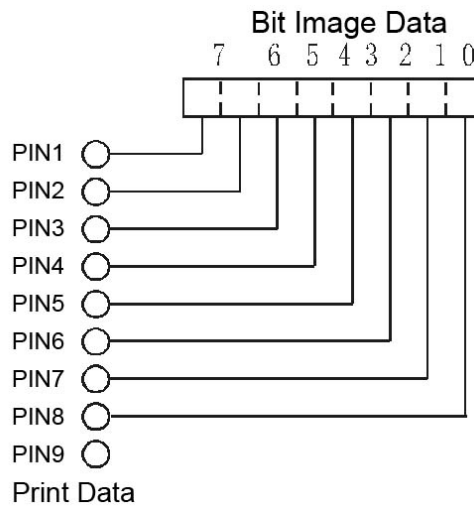

11. ESC - n

[Name] Turn underline mode on/off

[Format]

ASCII	ESC	-	n
Hex	1B	2D	n
Decimal	27	45	n

[Range] $n = 0, 1, 48, 49$

[Description] Turns underline mode on or off, based on the following values of n :

n	Function
0, 48	Turn off underline mode
1, 49	Turn on underline mode

- [Details]
- The printer can underline all characters (including right-side character spacing), but cannot underline the space set by **HT**.
 - Underline mode can also be turned on or off by using **ESC !**.
 - This command is ignored when n exceeds the specified range.
 - This command does not affect the setting of Kanji characters.

[Default] n = 0

12. ESC 2

[Name] Select default line spacing

[Format]	ASCII	ESC	2
	Hex	1B	32
	Decimal	27	50

[Description] Selects 1/6-inch (approximately 4.23mm) line spacing.

[Reference] ESC 3

13. ESC 3 n

[Name] Set line spacing

[Format]	ASCII	ESC	3	n
	Hex	1B	33	n
	Decimal	27	51	n

[Range] $0 \leq n \leq 255$

[Description] Sets the line spacing to $[n \times 0.176 \text{ mm } (1/44 \text{ inches})]$.

[Default] n = 24

[Reference] ESC 2

14. ESC <

[Name] Return home

[Format]	ASCII	ESC	<
	Hex	1B	3C
	Decimal	27	60

[Description] Moves the print head to the standby position.

[Details]

- Print head moves to the left end first, then right end and finally back to the left end.
- Left end position is detected by the initial position sensor
- For the detection of initial position, print position can be offset when using this command.

15. ESC ? n

[Name] Cancel user-defined characters

[Format]	ASCII	ESC	?	n
	Hex	1B	3F	n
	Decimal	27	63	n

[Range] $32 \leq n \leq 126$

[Description] Cancels user-defined characters.

[Details]

- This command cancels the pattern defined for the character code specified by *n*. After the user-defined characters are canceled, the corresponding pattern of the internal character is printed.
- This command deletes the pattern defined for the specified code in the font selected by **ESC !**.
- If a user-defined character has not been defined for the specified character code, the

printer ignores this command.

[Reference] ESC &, ESC %

16. ESC @

[Name] Initialize printer

[Format] ASCII ESC @
Hex 1B 40
Decimal 27 64

[Description] Clears the data in the print buffer and resets the printer mode to the mode that is in effect when the power is turned on.

[Details] • The DIP switch settings are not checked again.

17. ESC D n1...nk NUL

[Name] Set horizontal tab positions

[Format] ASCII ESC D n1...nk NUL
Hex 1B 44 n1...nk NUL
Decimal 27 68 n1...nk NUL

[Range] $1 \leq n \leq 255$
 $0 \leq k \leq 32$

[Description] Sets horizontal tab positions.

- n specifies the column number for setting a horizontal tab position from the beginning of the line.
- k indicates the total number of horizontal tab positions to be set.

[Details] • The horizontal tab position is stored as a value of [character width x n] measured from the beginning of the line. The character width includes the right-side character spacing, and double-width characters are set with twice the width of normal characters.

- This command cancels the previous horizontal tab settings.
- When setting $n = 8$, the print position is moved to column 9 by sending **HT**.
- Up to 32 tab positions ($k = 32$) can be set. Data exceeding 32 tab positions is processed as normal data.
- Transmit [n] k in ascending order and place a NUL code 0 at the end. When [n] k is less than or equal to the preceding value [n] $k-1$, tab setting is finished and the following data is processed as normal data.
- **ESC D NUL** cancels all horizontal tab positions.
- The previously specified horizontal tab positions do not change, even if the character width changes.

[Default] The default tab positions are at intervals of 8 characters (columns 9, 17, 25...) for font B (7 x 9).

[Reference] HT

18. ESC E n

[Name] Turn emphasized mode on/off

[Format] ASCII ESC E n
Hex 1B 45 n

	Decimal	27	69	n
[Range]	0 ≤ n ≤ 255			
[Description]	Turns emphasized mode on or off. <ul style="list-style-type: none"> • When the LSB of n is 0, emphasized mode is turned off. • When the LSB of n is 1, emphasized mode is turned on. 			
[Details]	<ul style="list-style-type: none"> • Only the least significant bit of n is enabled. • Bit image is not to be emphasized. • This command and ESC ! turn on and off emphasized mode in the same way. • Printer output is the same in double-strike mode (ESC G) and in emphasized mode. • Alphanumeric characters and Kanji characters are affected by this command. 			
[Note]	• Bi-direction print is with a lower speed in the emphasized mode.			
[Default]	n = 0			
[Reference]	ESC !, ESC G			

19. ESC G n

[Name]	Turn on/off double-strike mode			
[Format]	ASCII	ESC	G	n
	Hex	1B	47	n
	Decimal	27	71	n
[Range]	0 ≤ n ≤ 255			
[Description]	Turns double-strike mode on or off. <ul style="list-style-type: none"> • When the LSB of n is 0, double-strike mode is turned off. • When the LSB of n is 1, double-strike mode is turned on. 			
[Details]	<ul style="list-style-type: none"> • Only the least significant bit of n is enabled. • Bit image is not to be double-strike. • Printer output is the same in double-strike mode and in emphasized mode (ESC E). • Alphanumeric characters and Kanji characters are affected by this command. 			
[Note]	• Bi-direction print is with a lower speed in the double-strike mode.			
[Default]	n = 0			
[Reference]	ESC E			

20. ESC J n

[Name]	Print and feed paper			
[Format]	ASCII	ESC	J	n
	Hex	1B	4A	n
	Decimal	27	74	n
[Range]	0 ≤ n ≤ 255			
[Description]	Print the data in the print buffer and feeds the paper [n × 0.176mm (1/44inches)].			
[Details]	<ul style="list-style-type: none"> • After printing is completed, this command sets the print starting position to the beginning of a line. • The paper feed amount set by this command does not affect the values set by ESC 2 or ESC 3. 			
[Reference]	ESC K			

21. ESC K n

[Name] Print and reverse feed paper

[Format] ASCII ESC K n
Hex 1B 4B n
Decimal 27 75 n

[Range] $0 \leq n \leq 48$

[Description] Print the data in the print buffer and reverse feeds the paper [$n \times 0.176\text{mm}$ (1/44inches)].

[Details] • If n exceeds the specified range, printer prints data but do not reverse feed paper.

[Note] • Do not execute this command twice at a time.
• Reverse feed paper may cause the following problems:
1) Incorrect line spacing.
2) Printing noise is larger than in normal situation.
3) Paper may be dirtied by friction with ribbon.

[Reference] ESC J

22. ESC M n

[Name] Select character font

[Format] ASCII ESC M n
Hex 1B 4D n
Decimal 27 77 n

[Range] $n=0, 1, 48, 49$

[Description] Select character font:

n	Function
0, 48	Font A (9 x 9) selected
1, 49	Font B (7 x 9) selected

[Default] $n = 1$

23. ESC R n

[Name] Select an international character set

[Format] ASCII ESC R n
Hex 1B 52 n
Decimal 27 82 n

[Range] $0 \leq n \leq 15$

[Description] Select an international character set by setting n to the following values:

n	Character Set
0	U.S.A
1	France
2	Germany
3	U.K.
4	Denmark
5	Sweden
6	Italy

7	Spain I
8	Japan
9	Norway
10	Denmark II
11	Spain II
12	Latin America
13	Korea
14	Slovenia/Croatia
15	China

24. ESC U n

[Name] Turn unidirectional print mode on/off

[Format]

ASCII	ESC	U	n
Hex	1B	55	n
Decimal	27	85	n

[Range] $0 \leq n \leq 255$

[Description] Turn unidirectional print mode on/off.

- When the LSB of n is 0, unidirectional print mode is turned off.
- When the LSB of n is 1, unidirectional print mode is turned on.

[Details]

- Only the least significant bit of n is enabled.
- The print direction of unidirectional print mode is from left to right.
- Use unidirectional print mode to make horizontal position tidy.

[Default] $n = 0$

25. ESC a n

[Name] Select justification

[Format]

ASCII	ESC	a	n
Hex	1B	61	n
Decimal	27	97	n

[Range] $0 \leq n \leq 2$, $48 \leq n \leq 50$

[Description] Aligns all data in one line to the specified position

n selects the justification as follows:

n	Justification
0, 48	Left justification
1, 49	Center
2, 50	Right justification

[Details]

- The command is enabled only when processed at the beginning of a line.
- This command justifies the space area of the data skipped by command **HT**.

[Default] $n = 0$

[Example]

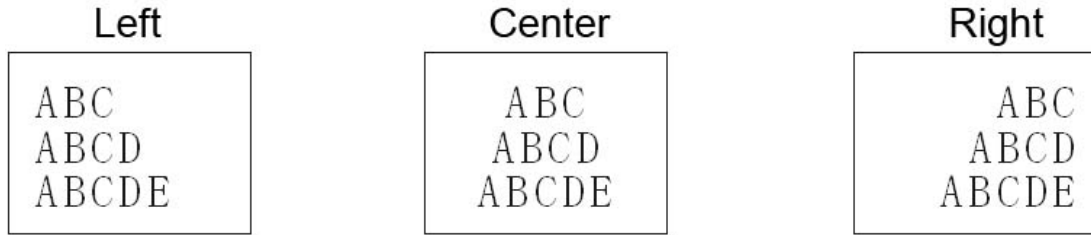

26. ESC c 5 n

[Name] Enable/disable panel buttons

[Format]	ASCII	ESC	c	5	n
	Hex	1B	63	35	n
	Decimal	27	99	53	n

[Range] $0 \leq n \leq 255$

[Description] Enable or disable the panel buttons.

- When the LSB of n is 0, the panel buttons are enabled.
- When the LSB of n is 1, the panel buttons are disabled.

[Details] • Only the least significant bit of n is enabled.

• When the panel buttons are disabled, none of them are usable, including FEED button. Use **GS z 0** to set paper loading latency time, in which FEED button is enabled to feed paper.

[Default] $n = 0$

27. ESC d n

[Name] Print and feed n lines

[Format]	ASCII	ESC	d	n
	Hex	1B	64	n
	Decimal	27	100	n

[Range] $0 \leq n \leq 255$

[Description] Prints the data in the print buffer and feeds n lines.

- [Details]
- This command sets the print starting position to the beginning of the line.
 - This command does not affect the line spacing set by **ESC 2** or **ESC 3**.
 - The maximum paper feed amount is 1016 mm (40 inches). If the paper feed amount ($n \times$ line spacing) of more than 1016 mm (40 inches) specified, the printer feeds the paper only 1016 mm (40 inches).

[Reference] ESC e

28. ESC e n

[Name] Print and reverse feed n lines

[Format]	ASCII	ESC	e	n
	Hex	1B	65	n
	Decimal	27	101	n

[Range] $0 \leq n \leq 2$

[Description] Prints the data in the print buffer and feeds n lines.

- [Details]
- If n exceeds the specified range, for example, over 8.467mm(48/100inches), printer prints data but do not reverse feed paper.

- [Note]
- Do not execute this command twice at a time.
 - Reverse feed paper may cause the following problems:
 - 1) Incorrect line spacing.
 - 2) Printing noise is larger than in normal situation.
 - 3) Paper may be dirtied by friction with ribbon.

[Reference] ESC d

29. ESC p m t1 t2

[Name] Generate pulse

[Format]

ASCII	ESC	p	m	t1	t2
Hex	1B	70	m	t1	t2
Decimal	27	112	m	t1	t2

[Range]

m = 0, 1, 48, 49

$0 \leq t1 \leq 255$

$0 \leq t2 \leq 255$

[Details]

- The pulse ON time is [t1 x 2 ms] and the OFF time is [t2 x 2 ms].
- If t2 < t1, the OFF time is [t1 x 2 ms]
- If t2 is less than 50, then t2 is assumed to be 50.

30. ESC r n (#)

[Name] Select print color

[Format]

ASCII	ESC	t	n
Hex	1B	72	n
Decimal	27	114	n

[Range] n = 0, 1, 48, 49

[Description] Selects print color:

n	Color
0, 48	Black
1, 49	Red

[Note]

- The command is enabled only when processed at the beginning of a line.
- Only available in double-color model.

[Default] n = 0

31. ESC t n

[Name] Select character code table

[Format]

ASCII	ESC	t	n
Hex	1B	74	n
Decimal	27	116	n

[Range] $0 \leq t \leq 5$, $16 \leq n \leq 19$

[Description] Selects a page n from the character code table:

n	Page
0	PC437 [U.S.A. & Europe Standard]
1	Katakana
2	PC850: Multilingual

3	PC860: Portuguese
4	PC863 [Canadian & French]
5	PC865: Nordic
16	WPC1252
17	PC866: Cyrillic*2
18	PC852: Latin2
19	PC858

32. ESC { n

[Name] Turn upside-down printing mode on/off

[Format] ASCII ESC { n
Hex 1B 7B n
Decimal 27 123 n

[Range] $0 \leq n \leq 255$

[Description] Turns upside-down printing mode on or off.

- When the LSB of n is 0, upside-down printing mode is turned off.
- When the LSB of n is 1, upside-down printing mode is turned on.

[Details]

- Only the least significant bit of n is enabled.
- This command is enabled only when processed at the beginning of a line.
- In upside-down printing mode, the printer rotates the line to be printed by 180 and then prints it.

[Default] n = 0

[Example]

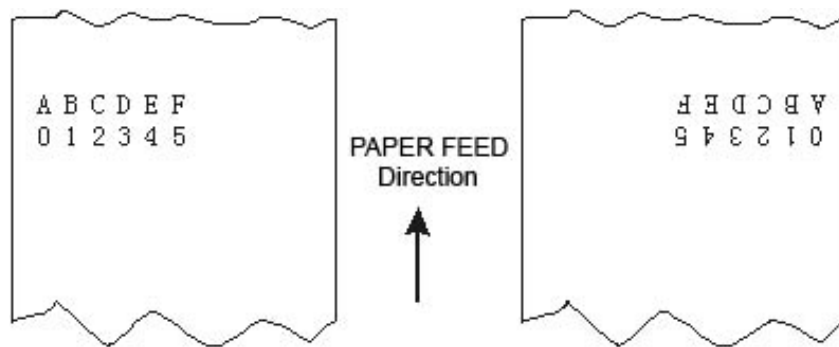

33. GS (A pL pH n m

[Name] Hexadecimal Dumping mode

[Format] ASCII GS (A pL pH n m
Hex 1D 28 41 pL pH n m
Decimal 29 40 65 pL pH n m

[Range] $(pL+pH \times 256) = 2$ (pL=2,pH=0)
n=0, 48
m=1, 49

34. ①GS V m ②GS V m n

[Name] Select cut mode and cut paper

[Format] ①ASCII GS V m
 Hex 1D 56 m
 Decimal 29 86 m

②ASCII GS V m n
 Hex 1D 56 m n
 Decimal 29 86 m n

[Range] ①m = 0, 48, 1, 49
 ②m =65, 66, 0 ≤ n ≤255

[Description] Selects a mode for cutting paper and executes paper cutting. The value of m selects the mode as follows:

M	Cutting Mode
0, 48	Full cut
1, 49	Partial cut
65,66	Feed paper (cutting position + [n × (vertical motion unit)]), and cut the paper partially (one point left uncut).

- This command is effective only processed at the beginning of a line.
- When m=0, 48, 1, 49, printer cuts paper directly.
- When n=65,66, printer feeds paper [cutting position + [n × (vertical motion unit)]] and cuts paper partially.
- Feed paper is measured by vertical motion unit.

35. GS a n

[Name] Enable/Disable Automatic Status Back (ASB)

[Format] ASCII GS a n
 Hex 1D 61 n
 Decimal 29 97 n

[Range] 0 ≤ n ≤ 255

[Description] Enables or disables ASB and specifies the status items to include, by using n as follows:

Bit	On/Off	Hex	Decimal	Status for ASB
0	Off	00	0	Drawer kick-out connector pin 3 status disabled.
	On	01	1	Drawer kick-out connector pin 3 status enabled.
1	-	-	-	Undefined.
2	Off	00	0	Error status disabled.
	On	04	4	Error status enabled.
3	Off	00	0	Paper roll sensor status disabled.
	On	08	8	Paper roll sensor status enabled.

4-7	-	-	-	Undefined.
-----	---	---	---	------------

[Default] n = 0

36. GS r n

[Name] **Transmit status**

[Format] ASCII GS r n
Hex 1D 72 n
Decimal 29 114 n

[Range] $1 \leq n \leq 2$, $49 \leq n \leq 50$

[Description] Transmits the status specified by *n* as follows:

n	Function
1, 49	Transmits paper sensor status
2, 50	Transmits drawer kick-out connector status

- [Details]
- When DTR/DSR control is selected, the printer transmits only 1 byte after confirming the host is ready to receive data (DSR signal is SPACE). If the host computer is not ready to receive data (DSR signal is MARK), the printer waits until the host is ready.
 - When XON/XOFF control is selected, the printer transmits only 1 byte without confirming the condition of the DSR signal.
 - This command is executed when the data in the receive buffer is developed. Therefore, there may be a time lag between receiving this command and transmitting the status, depending on the receive buffer status.
 - When Automatic Status Back (ASB) is enabled by command **GS a**, the status transmitted by **GS r** and the ASB status must be differentiated using the table in Appendix G.
 - The status types to be transmitted are shown below:

Paper sensor status (*n* = 1, 49):

Bit	0/1	Hex	Decimal	Status
0, 1	0	00	0	Paper roll near-end sensor: paper adequate.
	1	03	3	Paper roll near-end sensor: paper near end.
2, 3	0	00	0	Paper roll end sensor: paper adequate.
	1	0c	12	Paper roll near-end sensor: paper near end.
4	0	00	0	Not used. Fixed to Off.
5, 6		---	---	Undefined.
7	0	00	0	Not used. Fixed to Off.

Drawer kick-out status (*n* = 2, 50):

Bit	0/1	Hex	Decimal	Status
0	0	00	0	Drawer kick-out connector pin 3 is LOW.
	1	01	1	Drawer kick-out connector pin 3 is HIGH.
1-3		---	---	Undefined.
4	0	00	0	Not used. Fixed to Off.

5, 6		---	---	Undefined.
7	0	00	0	Not used. Fixed to Off.

[Reference] DLE EOT, GS a

37. GS z 0 t1 t2

[Name] Set online recovery wait time

[Format] ASCII GS z 0 t1 t2
Hex 1D 7A 30 t1 t2
Decimal 29 122 48 t1 t2

[Range] $0 \leq t1 \leq 255$
 $0 \leq t2 \leq 255$

[Description] This command sets the paper wait time to $t1 \times 0.5$ seconds and the recovery confirmation time to $t2 \times 0.5$ seconds.

- $t1 = 0$ Set to recovery confirmation status when new paper roll is installed.
- $t2 = 0$ Cancel the recovery confirmation time.

[Details] • Shortage of paper makes printer off-line. When new paper roll is installed and after the specified recovery wait time, the printer will be on-line again.

• The paper wait time is within $t1 \times 0.5$ seconds from the time the printer finishes loading the paper. During this time, Paper can be fed by pressing the FEED button and the printer can be set on-line by using the **DLE ENQ** command. After the paper wait time, printer is on the recovery confirmation status.

• During the paper wait time, the time of feeding paper by pressing FEED button is not counted in the paper wait time. Loading the paper or paper shortage is sensed, printer waits the paper wait time ($t1 \times 0.5$ seconds) and recovery confirmation time ($t2 \times 0.5$ seconds) to return back on-line.

• The recovery confirmation time is within $t2 \times 0.5$ seconds of the end of the paper wait time. During this time, the PAPER LED flashes. However, the printer can be on-line by pressing the PAPER FEED button. The printer will be on-line when the recovery confirmation time ends or by using the **DLE ENQ 0** command.

• During the recovery confirmation time, paper cannot be fed by pressing the FEED button.

• When $t2=0$ and PAPER LED flashes, the printer can be on-line by using the **DLE ENQ 0** command or pressing the FEED button.

• During the online recovery wait time, if the paper sensor finds out the paper near-end status, printer returns to the status of waiting paper load.

[Default] $t1 = 0, t2 = 0$

[Reference] DLE EOT, DLE ENQ, GS a

38. FS ! n

[Name] Set print mode(s) for Kanji characters

[Format] ASCII FS ! n
Hex 1C 21 n
Decimal 28 33 n

[Range] $0 \leq n \leq 255$

[Description] Sets the print mode for Kanji characters, using n as follows:

Bit	0/1	Hex	Decimal	Function
0, 1		---	---	Undefined.
2	0	00	0	Double-width mode is OFF.
	1	04	4	Double-width mode is ON.
3	0	00	0	Double-height mode is OFF.
	1	08	8	Double-height mode is ON.
4-6		--	--	Undefined.
7	0	00	0	Underline mode is OFF.
	1	80	128	Underline mode is ON.

[Details] • When both double-width and double-height modes are set (including right- and left-side character spacing), quadruple-size characters are printed.

- The printer can underline all characters (including right- and left-side character spacing), but cannot underline the space set by **HT**.

[Default] n = 0

[Reference] FS - , FS W

39. FS &

[Name] Select Kanji characters mode

[Format] ASCII FS &
Hex 1C 26
Decimal 28 38

[Description] Select Kanji characters mode

[Details] • When Kanji characters mode is selected, the printer checks to find out whether the code is Kanji character or not. If it is, the 1st and 2nd bytes will be processed.
• For Kanji characters, the 1st byte is processed first and the 2nd byte after.
• Kanji characters mode is set when printer is power on.

[Reference] FS . , FS C

40. FS - n

[Name] Turn underline mode on/off for Kanji characters

[Format] ASCII FS - n
Hex 1C 2D n
Decimal 28 45 n

[Range] $0 \leq n \leq 1$

[Description] Turns underline mode on/off for Kanji characters, based on the following values of n.

n	Function
0, 48	Turns off underline mode for Kanji characters
1, 49	Turns on underline mode for Kanji characters (1-dot thick)
2, 50	Turns on underline mode for Kanji characters (2-dot thick)

[Details] • The printer can underline all characters (including right- and left-side character spacing), but cannot underline the space set by **HT**.

[Default] n = 0

[Reference] FS !

41. FS .

[Name] Cancel Kanji character mode

[Format] ASCII FS .
Hex 1C 2E
Decimal 28 46

[Description] Cancel Kanji character mode

[Details] • If the Kanji character mode is canceled, all codes of characters will be processed 1byte per time as ASCII.
• Kanji characters mode is set when printer is power on.

[Reference] FS & , FS C

42. FS 2 c1 c2 d1 ...dk

[Name] Define user-defined Kanji characters

[Format] ASCII FS 2 c1 c2 d1... dk
Hex 1C 32 c1 c2 d1... dk
Decimal 28 50 c1 c2 d1... dk

[Range] <Available in Simplified Kanji supporting models>

c1 = FEH
A1H ≤c2 ≤FEH
0 ≤d ≤255
k = 32

[Description] • Defines user-defined Kanji characters for the character codes specified by c1 and c2.

[Details] • c1 and c2 indicate character codes for the defined characters. The range of values for c1 and c2 differ depending on the character code system used.
• d indicates the dot data. The data is 32bytes that is 16 columns and 2bytes in every column.
• When user-defined characters are defined, the previously defined Kanji characters can be redefined again but no more new Kanji characters can be defined.
• Once the user-defined characters have been defined, they are valid till executes redefine, **ESC @**, **FS ?** command, printer reset or printer power-off.

[Default] All spaces

[Reference] FS ? , FS C

43. FS ? c1 c2

[Name] Cancel user-defined Kanji characters

[Format] ASCII FS ? c1 c2
Hex 1C 3F c1 c2
Decimal 28 63 c1 c2

[Range] <Available in Simplified Kanji supporting models>

c1 = FEH
A1H ≤c2 ≤FEH

[Description] Cancels user-defined Kanji characters

- [Details] • This command cancels the user-defined Kanji characters specified by *c1* and *c2*. Spaces are the substitute.
 • If there is no user-defined Kanji characters defined, the printer will ignore this command.

[Reference] FS 2 , FS c

44. FS S n1 n2

[Name] Set Kanji characters spacing

[Format]	ASCII	FS	S	n1	n2
	Hex	1C	53	n1	n2
	Decimal	28	83	n1	n2

[Range] 0 ≤ n1 ≤ 32
 0 ≤ n2 ≤ 32

[Description] Sets left- and right-side Kanji character spacing *n1* and *n2*, respectively.

- [Details] • When double-width mode is set, the left- and right-side character spacing is twice the normal value.
 • Unit of spacing between Kanji characters is half dot.

[Default] n1 = 0 ; n2 = 2

45. FS W n

[Name] Turn quadruple-size mode on/off for Kanji characters

[Format]	ASCII	FS	W	n
	Hex	1C	57	n
	Decimal	28	87	n

[Range] 0 ≤ n ≤ 255

[Description] Turns quadruple-size mode on/off for Kanji characters.

- When the LSB of *n* is 0, quadruple-size mode for Kanji characters is turned off.
- When the LSB of *n* is 1, quadruple-size mode for Kanji characters is turned on.

- [Details] • Only the lowest bit of *n* is valid.
 • In quadruple-size mode, the printer prints the same size characters as when double-width and double-height modes are both turned on.

[Default] n = 0

[Reference] FS !

46. GS (F PL PH a m nL nH

[Name] Set the offset of black mark position

[Format]	ASCII	GS	(F	pL	pH	a	m	nL	nH
	Hex	1D	28	46	pL	pH	a	m	nL	nH
	Decimal	29	40	70	pL	pH	a	m	nL	nH

- [[Details] • The parameters set by this command won't be lost even without power supply.
 • This command sets the black-mark control enabled and sets the offset value of the paper cutting/tearing position or print starting position relative to the black mark sensor position.
 • Parameters of this command:

$$pL+(pH \times 256) \equiv 4 \quad (pL=4, pH=0)$$

$$a=1, 2; m=0, 48 \text{ or } 1, 49$$

$$0 \leq (nL+nH \times 256) < 1700$$

a indicates the offset value of paper cutting/tearing position or of print starting position:

a	Function
1	Sets the offset value of the print starting position relative to the black mark sensor position.
2	Sets the offset value of the paper cutting/tearing position relative to the black mark sensor position.

- $m=0, 48$, Sets the paper feed direction as the calculation direction of offset.
- $m=1, 49$, Sets the paper reverse feed direction as the calculation direction of offset.
- nL, nH Sets the offset value to $(nL+nH \times 256) \times 0.176\text{mm}$.
- **GS FF** and **GS V** is valid only when this command is executed.
- Setting offset of the print starting position ($a=1$) is enabled in **GS FF**.
- Setting offset of the paper cutting/tearing position ($a=2$) is enabled in **GS V m**.
- Default value of nL and nH is 0, viz., when the black mark sensor senses the black mark, the print head position corresponding to where on the paper is set as the print starting position, and the paper cutting/tearing position corresponding to where on the paper is set as the paper cutting/tearing position.
- Explanation of the calculation of the paper cutting/tearing position offset and print starting position offset.
 1. When the length (L) between paper cutting/tearing position and black mark position is the same as the printer inherency mechanism value ($L0$), and the length (Q) between print starting position and printer inherency mechanism value ($Q0$), offset set by **GS (F** is 0. (Chart 1)
 2. When length (L) between paper cutting/tearing position and black mark position is less than the printer inherency mechanism value ($L0$) (Chart 2), offset set by **GS (F** is calculated as follows:
 Paper cutting/tearing position offset = $(L0 - L)/0.176$ dots
 When length (L) between paper cutting/tearing position and black mark position is larger than the printer inherency mechanism value ($L0$) (Chart 3), offset set by **GS (F** is calculated as follows:
 Paper cutting/tearing position offset = $(L0 + \text{length of two neighbor black mark} - L)/0.176$ dots
Note: When setting the paper cutting/tearing position offset, parameter a of **GS (F** is 2. ($a = 2$)
 3. When paper cutting/tearing position offset is not 0 or the length (Q) of print starting position is larger than the printer inherency mechanism value ($Q0$), offset set by **GS (F** is calculated as follows:
 Print starting position offset = $(Q-Q0)/0.176 + \text{paper cutting/tearing position offset}$
Note: When setting the paper cutting/tearing position offset, parameter a of **GS (F** is 2. ($a = 1$)
 4. Inherence mechanism value of mechanism DP330:

$L_0=43\text{mm}$, $Q_0=18\text{mm}$

When the mechanism is installed in the printer enclosure, values of L_0 and Q_0 will change, that is,

$$L_0=43+ \Delta L, Q_0=18+ \Delta L$$

5. ΔL calculation method:

- 1) Load the paper first, and trim the paper edge;
- 2) Send 20 characters "E" to the printer and print these out;
- 3) Feed the paper to proper position, and measure the length within the paper end and the top of "EEEEEEEEEEEEEEEEEEEEEEEE", which minus 18ms equals ΔL .

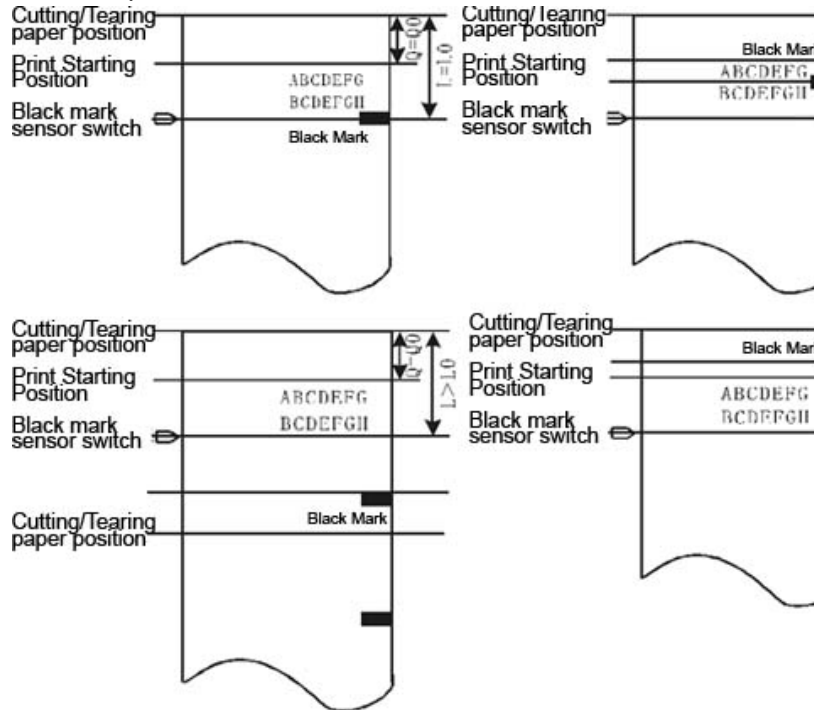

Examples for the black mark position control for specified paper.

The paper tearing position assumed to be the printer cutter position, that is $L_0=43\text{mm}$ and $Q_0=18\text{mm}$

【Example 1】 Paper: Cutting/tearing position is on the printed black mark position, which is 25mm distance away from the print starting position.

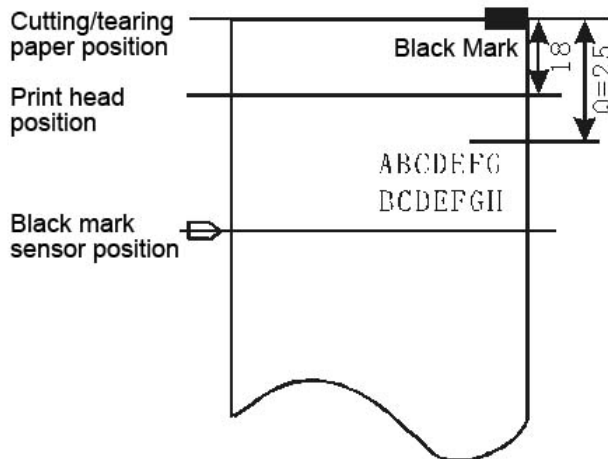

- Cutting/tearing paper position offset calculation:

For black mark position is the same as the cutting/tearing paper position, that is $L=0$, then
 Cutting/tearing paper position offset = $(43-0) / 0.176 = 244$ dots

- Set the cutting/tearing paper position offset by the following command:
`GS (F <4><0><2><0><244><0>`
- Print starting position offset calculation:
 $(25-18)/0.176+244=284$ dots
- Set the print starting position offset by the following command:
`GS (F <4><0><1><0><28><1>`
- After finished these steps, and when every receipt is printed:
 Feed paper to the print starting position by using command **GS FF**;
 Data is sent to the printer and printed out line by line;
 Feed paper to the cutting/tearing position by using command **GS V m**, where the receipt
 can be cut or tear.

【Example 2】 Paper: The distance between cutting/tearing position and black mark position is 12mm, and that between print starting position and cutting/tearing position is 18mm.

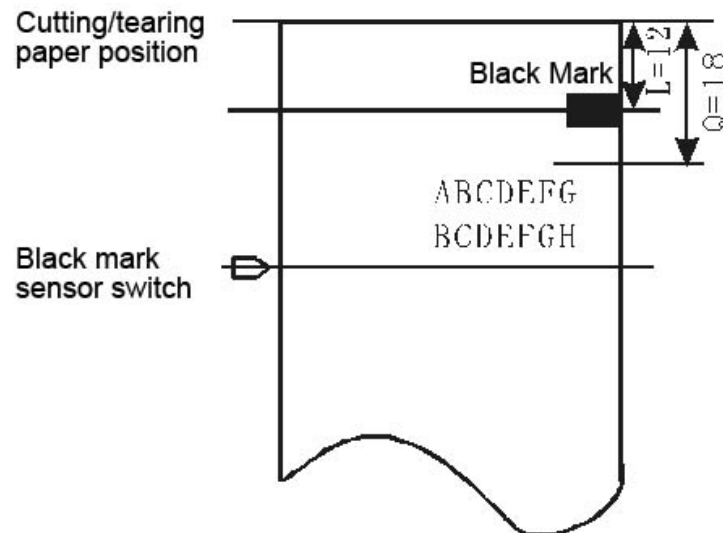

- Cutting/tearing paper position offset calculation:
 For the length within black mark position and the cutting/tearing paper position is less than L_0 (43mm), then
 Cutting/tearing paper position offset = $(43-12)/0.176=176$ dots
- Set the cutting/tearing paper position offset by the following command:
`GS (F <4><0><2><0><176><0>`
- Print starting position offset calculation:
 $(18-18)/0.176+176=176$ dots
- Set the print starting position offset by the following command:
`GS (F <4><0><1><0><176><0>`
- After finished these steps, and when every receipt is printed, the command list to use is the same as the one in Example 1.

【Example 3】 Paper: Paper length is 140mm;

Length within black mark position and cutting/tearing paper position is 130mm;
 Length within print starting position and cutting/tearing paper position is 20mm.

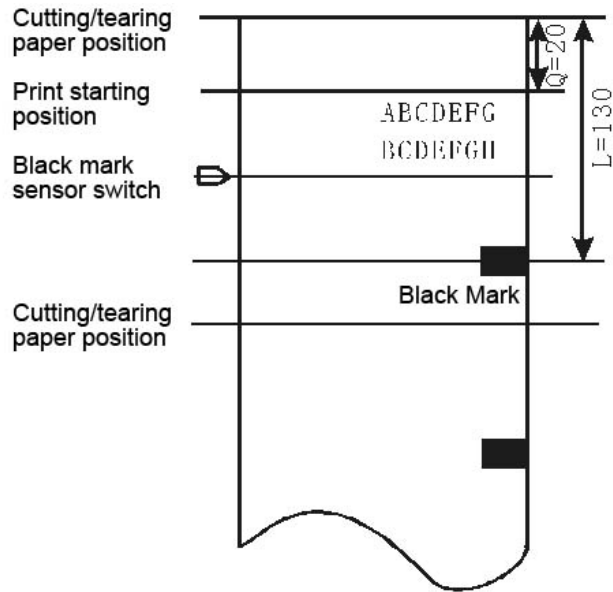

- Cutting/tearing paper position offset calculation:
For the length within black mark position and the cutting/tearing paper position is larger than L0 (43mm), then

$$\text{Cutting/tearing paper position offset} = (43+140-130)/0.176=301 \text{ dots}$$

- Set the cutting/tearing paper position offset by the following command:
GS (F <4><0><2><0><45><1>
- Print starting position offset calculation:
(20-18)/0.176+301=312 dots
- Set the print starting position offset by the following command:
GS (F <4><0><1><0><56><1>
- After finished these steps, and when every receipt is printed, the command list to use is the same as the one in Example 1.

Note:

1. When both cutting/tearing paper position offset and print starting position offset is 0, only need to use command **GS V m** to complete the location print.
2. When cutting/tearing paper position offset is not equal 0, **GS (F** is used to set the cutting/tearing paper position offset to a=2 and the print starting position offset to a=1.
3. Only when print starting position is set, **GS FF** can be use to feed paper to the print starting position, otherwise, situations of unfaithful location or feeding a blank paper may happen.
4. Once **GS (F** is used to modify the previous-set offset, situations of unfaithful location or feeding a blank paper may happen, but the next receipts will be print correctly.

47. GS FF

[Name] Feed paper to the black mark position

[Format]	ASCII	GS	FF
	Hex	1D	0C
	Decimal	29	12

[Details] • This command is valid in the specified range of black mark position control.

- Senses black mark and feeds paper to the beginning of print position set by the command **GS** (F(a=1)..
- When black mark paper is on the print position, no FEED operation is processed.
- No reverse feed is executed in partial cut mode.

48. ESC ^ n (*)

[Name] Set length of the receipt

[Format] ASCII ESC ^ n
 Hex 1B 5E n
 Decimal 27 94 n

- [Details]
- The parameters set by this command are invalid when power turned off or in initialization.
 - When this command sets the length of the receipt, printer reverse feed paper to the print starting position
 - Reverse feed paper length is $n \times 0.1764\text{mm}$.

49. ESC ~ nL nH (*)

[Name] Feed paper to the end of receipt

[Format] ASCII ESC ~ nL nH
 Hex 1B 7E nL nH
 Decimal 27 126 nL nH

- [Details]
- This command sets the receipt length to $(nL + nH \times 256) \times 0.1764\text{mm}$, and reverse feed paper to the print starting position set by **ESC ^ n**.

50. ESC DEL (*)

[Name] Feed paper to the end of receipt

[Format] ASCII ESC DEL
 Hex 1B 7F
 Decimal 27 127

- [Details]
- The printer receives this command and feeds paper [receipt length – printed length].

51. GS < (*)

[Name] Reset print head and feed black-mark paper to the start position

[Format] ASCII GS <
 Hex 1D 3C
 Decimal 29 60

- [Details]
- Moves print head to standby position and feeds black-mark paper to the print starting position.

52. ESC 0E9H (*)

[Name] Print start code

[Format]	ASCII	ESC	E9
	Hex	1B	E9
	Decimal	27	233

[Details] • The host computer send start code 1BH, OE9H (Hexadecimal) to printer. When the printer sends back the same code to the host computer, that means the communication before sending data has been set up successfully. At that time, the printer can receive and print any data and commands from the host computer. Printer returns 1B, E8 for errors or the shortage of paper.

53. ESC } (*)

[Name] Print end code

[Format]	ASCII	ESC	}
	Hex	1B	7D
	Decimal	27	125

[Details] • The host computer send end code 1BH, 7DH (Hexadecimal) to printer. When the printer finishes printing and receives the end code, it will send back the same code to the host computer and turns off the printer if there is no error. At that time, the printer receives start code 1BH, OE9H only and ignores any other commands and data. Printer returns 1B, E8 for errors or the shortage of paper.